

# PERGOLAS

JOSÉ A. GANDÍA-BLASCO CANALES

## TECHO. CEILING

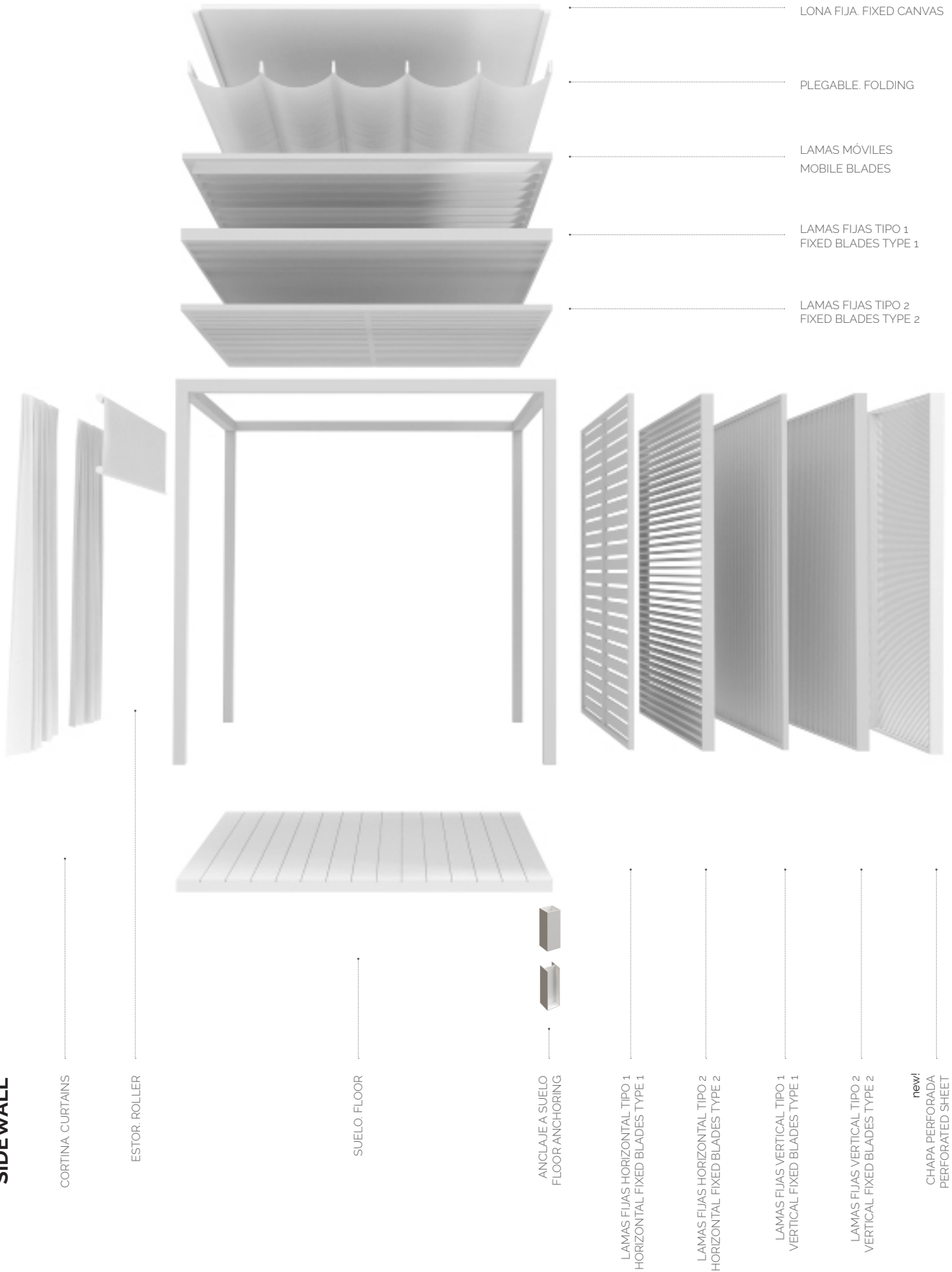

## CERRAMIENTO SIDEWALL

CORTINA. CURTAINS

ESTOR. ROLLER

SUELO. FLOOR

ANCLAJE A SUELO. FLOOR ANCHORING

LAMAS FIJAS HORIZONTAL TIPO 1. HORIZONTAL FIXED BLADES TYPE 1

LAMAS FIJAS HORIZONTAL TIPO 2. HORIZONTAL FIXED BLADES TYPE 2

LAMAS FIJAS VERTICAL TIPO 1. VERTICAL FIXED BLADES TYPE 1

LAMAS FIJAS VERTICAL TIPO 2. VERTICAL FIXED BLADES TYPE 2

new!  
CHAPA PERFORADA. PERFORATED SHEET

# PERGOLAS

JOSÉ A. GANDÍA-BLASCO CANALES

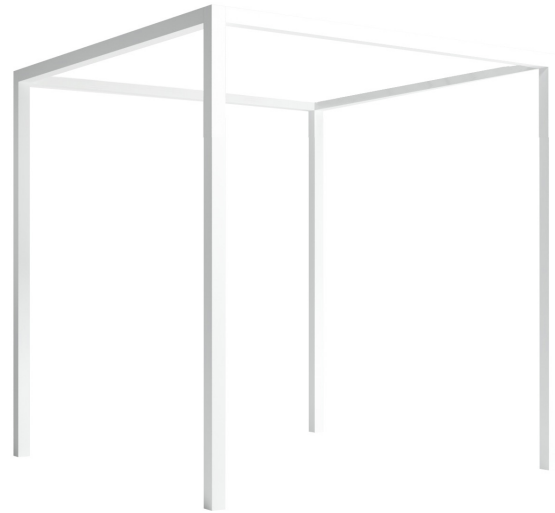
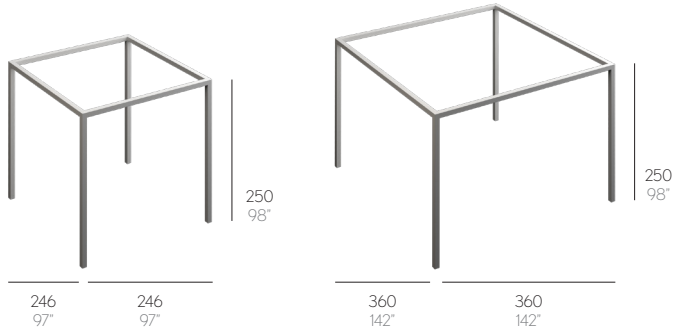

## MÓDULO 1

Aluminio anodizado o termolacado.  
Techos.  
Cerramientos (estor y cortinas).

## MODUL 1

Eloxiertes oder thermolackiertes Aluminium.  
Dächer.  
Schließungen (Jalousie und Vorhänge).

## MODULE 1

Aluminium anodisé ou thermolaqué.  
Toits.  
Fermetures (store et rideaux).

Module 1 - 246x246 cm/97"x97"

Estructura. Frame. Profil. Struttura. Structure. Frame

40,3 kg - 88,66 lbs 1 0,3 m<sup>3</sup> - 10,59 ft<sup>3</sup>

Module 1 - 360x360 cm/142"x142"

Estructura. Frame. Profil. Struttura. Structure. Frame

49,9 kg - 109,78 lbs 1 0,35 m<sup>3</sup> - 12,36 ft<sup>3</sup>

## MODULE 1

Anodized or thermo-lacquered aluminium.  
Ceilings.  
Sidewalls (roller and curtains).

## MODULO 1

Alluminio anodizzato o termolaccato.  
Tetti.  
Serramenti (tenda e tende).

## MODULE 1

Silver or powder coated aluminum.  
Ceilings.  
Sidewalls (roller and curtains).

## MATERIALES. MATERIALS. MATERIALEN. MATERIALI. MATERIAUX

### ALUMINIUM



### SOLTIS



### WIND

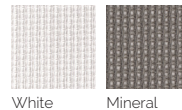

# PERGOLAS

JOSÉ A. GANDÍA-BLASCO CANALES

## TECHO. CEILING. DACH. TETTO. TOIT. CEILING

	LAMAS FIJAS TIPO 1 FIXED BLADES TYPE 1	LAMAS FIJAS TIPO 2 FIXED BLADES TYPE 2	LAMAS MÓVILES MOBILE BLADES	PLEGABLE FOLDING	LONA FIJA FIXED CANVAS
	230x230 168x344	230x230 168x344	230x230 168x344	230x230 344x344 230x468	230x230 344x344 230x468 344x696
<b>MODULE 1</b> 246x246x250h 360x360x250h	1 ud 2 ud	1 ud 2 ud	1 ud 2 ud	1 ud 1 ud	1 ud 1 ud
<b>MODULE 2</b> 484x246x250h 712x360x250h	2 ud 4 ud	2 ud 4 ud	2 ud 4 ud	2 ud 1 ud	1 ud 1 ud
<b>MODULE 6</b> 484x246x250h				1 ud	1 ud



230x230 cm/91"x91"  
 [kg] 65,1 kg - 143,22 lbs  
 [m³] 0,33 m³ - 11,65 ft³

168x344 cm/66"x135"  
 [kg] 69,3 kg - 152,46 lbs  
 [m³] 0,36 m³ - 12,71 ft³

**TECHO LAMAS FIJAS TIPO 1**  
**FIXED BLADES CEILING TYPE 1**  
**DACH MIT FESTEN LAMELLEN. TYP 1**  
**TETTO ALLUMINIO FISSO TIPO 1**  
**TOIT LAMES FIXES TYPE 1**



230x230 cm/91"x91"  
 [kg] 104,5 kg - 229,90 lbs  
 [m³] 0,63 m³ - 22,25 ft³

168x344 cm/66"x135"  
 [kg] 112,3 kg - 247,06 lbs  
 [m³] 0,59 m³ - 20,83 ft³

**TECHO LAMAS FIJAS TIPO 2**  
**FIXED BLADES CEILING TYPE 2**  
**DACH MIT FESTEN LAMELLEN. TYP 2**  
**TETTO ALLUMINIO FISSO TIPO 2**  
**TOIT LAMES FIXES TYPE 2**



230x230 cm/91"x91"  
 [kg] 75,5 kg - 116,10 lbs  
 [m³] 0,33 m³ - 11,65 ft³

168x344 cm/66"x135"  
 [kg] 79,8 kg - 175,56 lbs  
 [m³] 0,36 m³ - 12,71 ft³

**TECHO LAMAS MÓVILES**  
**MOVILES BLADES CEILING**  
**DACH MIT BEWEGLICHEN LAMELLEN**  
**TETTO ALLUMINIO MOBILE**  
**TOIT LAMES MOBILES**

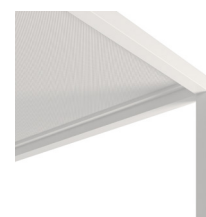

230x230 cm/91"x91"  
 [kg] 12,5 kg - 27,50 lbs  
 [m³] 0,06 m³ - 2,12 ft³

344x344 cm/135"x135"  
 [kg] 20,2 kg - 44,44 lbs  
 [m³] 0,08 m³ - 2,82 ft³

230x468 cm/91"x184"  
 [kg] 24,1 kg - 53,02 lbs  
 [m³] 0,09 m³ - 3,18 ft³

344x696 cm/135"x274"  
 [kg] 38,5 kg - 84,70 lbs  
 [m³] 0,14 m³ - 4,94 ft³

**TECHO LONA FIJA**  
**FIXED CANVAS CEILING**  
**FESTE DECKENPLANE**  
**TETTO IN TELONE FISSA**  
**TOIT EN TOILE FIXE**



230x230 cm/91"x91"  
 [kg] 22,8 kg - 50,16 lbs  
 [m³] 0,09 m³ - 3,18 ft³

344x344 cm/135"x135"  
 [kg] 35,3 kg - 77,66 lbs  
 [m³] 0,14 m³ - 4,94 ft³

230x468 cm/91"x184"  
 [kg] 45,1 kg - 99,22 lbs  
 [m³] 0,19 m³ - 6,71 ft³

**TECHO PLEGABLE**  
**FOLDING CEILING**  
**DACH KLAPPBARE**  
**TETTO PIEGABILE**  
**TOIT PLIABLE**



GANDÍA-BLASCO

# PERGOLAS

JOSÉ A. GANDÍA-BLASCO CANALES

## CERRAMIENTO. SIDEWALL. SCHLIEßUNGEN. SERRAMENTO. FERMETURE. SIDEWALL

SIDE OF MODULES	* LAMAS FIJAS HORIZONTAL TIPO 1 HORIZONTAL FIXED BLADES TYPE 1		* LAMAS FIJAS HORIZONTAL TIPO 2 HORIZONTAL FIXED BLADES TYPE 2		* LAMAS FIJAS VERTICAL TIPO 1 VERTICAL FIXED BLADES TYPE 1		* LAMAS FIJAS VERTICAL TIPO 2 VERTICAL FIXED BLADES TYPE 2		ESTOR ROLLER		CORTINA CURTAIN		
	230x234	172x234	230x234	172x234	230x234	172x234	230x234	172x234	230	344	set 246	set 360	set 484
246x250h	1 ud		1 ud		1 ud		1 ud		1 ud		1 ud		
360x250h	2 ud		2 ud		2 ud		2 ud		1 ud		1 ud		
484x250h											1 ud		

\*Cerramientos de lamas y chapa perforada solo disponibles en pérgolas con suelo.

\*Blades enclosures and perforated sheet are only available in pergolas with floor.



230x234 cm/91"x92"  
 65,4 kg - 143,88 lbs  
 0,34 m³ - 12,01 ft³

172x234 cm/68"x92"  
 48,6 kg - 106,92 lbs  
 0,25 m³ - 8,83 ft³

LAMAS FIJAS HORIZONTAL TIPO 1  
 HORIZONTAL FIXED BLADES TYPE 1  
 HORIZONTAL FESTEN LAMELLEN. TYP 1  
 ALLUMINIO FISSO ORIZZONTALE TIPO 1  
 LAMES FIXES HORIZONTALE TYPE 1

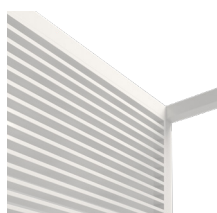

230x234 cm/91"x92"  
 104,6 kg - 230,12 lbs  
 0,56 m³ - 19,77 ft³

172x234 cm/68"x92"  
 79,2 kg - 174,24 lbs  
 0,42 m³ - 14,83 ft³

LAMAS FIJAS HORIZONTAL TIPO 2  
 HORIZONTAL FIXED BLADES TYPE 2  
 HORIZONTAL FESTEN LAMELLEN. TYP 2  
 ALLUMINIO FISSO ORIZZONTALE TIPO 2  
 LAMES FIXES HORIZONTALE TYPE 2



230x234 cm/91"x92"  
 64,9 kg - 142,78 lbs  
 0,34 m³ - 12,01 ft³

172x234 cm/68"x92"  
 48,7 kg - 107,14 lbs  
 0,25 m³ - 8,83 ft³

LAMAS FIJAS VERTICAL TIPO 1  
 VERTICAL FIXED BLADES TYPE 1  
 VERTICAL FESTEN LAMELLEN. TYP 1  
 ALLUMINIO FISSO VERTICALE TIPO 1  
 LAMES FIXES VERTICALE TYPE 1

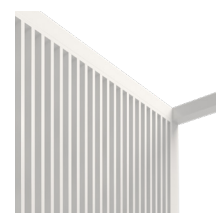

230x234 cm/91"x92"  
 104,6 kg - 230,12 lbs  
 0,56 m³ - 19,77 ft³

172x234 cm/68"x92"  
 79,7 kg - 175,34 lbs  
 0,42 m³ - 14,83 ft³

LAMAS FIJAS VERTICAL TIPO 2  
 VERTICAL FIXED BLADES TYPE 2  
 VERTICAL FESTEN LAMELLEN. TYP 2  
 ALLUMINIO FISSO VERTICALE TIPO 2  
 LAMES FIXES VERTICALE TYPE 2



230 cm/91"  
 9,3 kg - 20,46 lbs  
 0,05 m³ - 1,77 ft³

344 cm/135"  
 13,4 kg - 29,48 lbs  
 0,08 m³ - 2,82 ft³

Tela. Fabric. Stoff. Tutte. Tissu. Fabric  
 Soltis

ESTOR  
 ROLLER  
 JALOUSIE  
 TENDA  
 STORE



set side 246 cm/97"  
 2,5 kg - 5,50 lbs  
 0,03 m³ - 1,06 ft³

set side 360 cm/142"  
 3,5 kg - 7,70 lbs  
 0,05 m³ - 1,77 ft³

set side 484 cm/191"  
 4,9 kg - 10,78 lbs  
 0,06 m³ - 2,12 ft³  
 Tela. Fabric. Stoff. Tutte. Tissu. Fabric  
 Wind

CORTINAS  
 CURTAINS  
 VORHÄNGE  
 TENDE  
 RIDEAUX

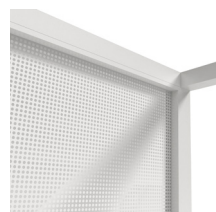

114,5x234 cm/45"x92"  
 25,2 kg - 55,44 lbs  
 0,28 m³ - 9,89 ft³

CHAPA PERFORADA  
 PERFORATED SHEET  
 PERFORIERTEM BLECH  
 ALLUMINIO PERFORATO  
 MÉTALLIQUE PERFORÉE



GANDÍA-BLASCO

# PERGOLAS

JOSÉ A. GANDÍA-BLASCO CANALES

## ANCLAJE AL SUELO. ANCHORAGE TO THE GROUND. VERANKERUNG AM BODEN. FISSAGGIO AL SUOLO. ANCRAGE AU SOL. ANCHORAGE TO THE GROUND

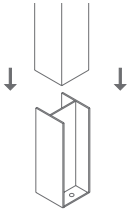

Para superficies regulares (hormigón, pavimentos...) el anclaje va atornillado al suelo. También para módulo con estores.

For regular surfaces (concrete, pavements...) the anchorage is screwed to the ground. Same system for modules with plastic canvas sidewalls.

Bei homogenen Oberflächen (Beton, Kachelböden,...) wird die Befestigung an den Boden geschraubt. Auch für Module mit Jalousien geeignet

Per superfici regolari (cemento, pavimenti, ecc.) la base va avvitata al suolo. Anche per modulo con tende.

Pour les surfaces régulières (béton, revêtements de sol, etc.) l'ancrage est vissé au sol. Aussi pour les modules avec stores.

For regular surfaces (concrete, pavements...) the anchorage is screwed to the ground. Same system for modules with plastic canvas sidewalls.

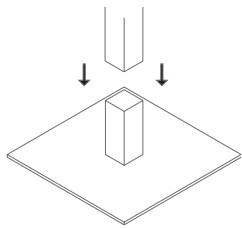

Para superficies irregulares (arena, césped...) el anclaje va atornillado a una placa de aluminio de 50x50 cm, que descansa sobre el suelo (sólo para módulo techo lonas móviles y módulo techo lona fija sin estores).

For irregular surfaces (sand, lawns...) the anchorage is screwed to an aluminium plate of 50x50 cm which lies on the ground, (only for modules with movable plastic fabric strips ceiling and modules with canvas ceiling).

Bei unregelmäßigen Oberflächen (Sand, Rasen,...) wird die Befestigung an eine auf dem Boden liegenden 50x50 cm große Aluplatte befestigt. (Nur für Module mit beweglichen Planen und für Module mit fester Überdachung ohne Jalousien geeignet).

Per le superfici irregolari (sabbia, prato, ecc.) la base va avvitata ad una piastra di alluminio di 50x50 cm, che verrà previamente posta sul suolo. (solo per modulo tetto teloni mobili e modulo telone fisso senza tende).

Pour les surfaces irrégulières (sable, gazon, etc.), l'ancrage est vissé à une plaque d'aluminium de 50x50 cm, qui repose sur le sol, (seulement pour les modules à toit en toile mobile et pour les modules à toit en toile fixe sans stores).

For irregular surfaces (sand, lawns...) the anchorage is screwed to an aluminum plate of 20"x20" which lies on the ground. Only for modules with movable plastic fabric strips ceiling and modules with canvas ceiling.

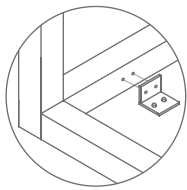

Para módulo y suelo se utilizarán escuadras interiores. Consultar unidades con departamento técnico.

For pergola and floor, internal brackets are used. For units, see the technical department.

Bei Pergola mt Boden mit Grundlage werden interne Befestigungswinkel benutzt. Wenden Sie sich an den technischen Dienst bezüglich der benötigten Einheiten.

Utiliser des équerres intérieures dans le cas de pergola dotée de plancher. Consulter les unités avec le département technique.

Per modulo e pavimento si utilizzeranno squadre di rinforzo interne. Consultare l'ufficio tecnico per avere istruzioni dettagliate.

For pergola and floor, internal brackets are used. For units, see the technical department.

## REFUERZO. REINFORCING. VERSTÄRKT. RINFORZO. RENFORCÉ. REINFORCING.

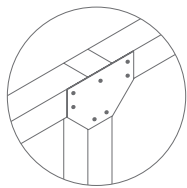

Refuerzo pilar central.  
Reinforcing angle bracket for front pillar.  
Verstärkungswinkel für frontseitige Pfeiler.  
Squadra di rinforzo pilastro frontale.  
Équerre de renfort pilier central.  
Reinforcing angle bracket for front pillar  
22x15h cm / 9"x6"h

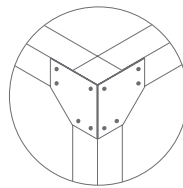

Escuadra refuerzo pilar lateral. Dos unidades por pilar.  
Reinforcing angle bracket for side pillar. Two units per pillar.  
Verstärkungswinkel für Seitenpfeiler. Zwei Einheiten pro Säule.  
Squadra di rinforzo pilastro laterale. Deux unités par pilier.  
Équerre de renfort pilier latéral. Due unità per ogni pilastro.  
Reinforcing angle bracket for side pillar. Two units per pillar.  
15x15h cm / 6"x6"h

Escuadra de refuerzo, recomendada para zonas expuestas a fuertes vientos. Pieza disponible para todos los módulos.

Wall bracket, recommended for zones exposed to strong winds. Piece suitable for all pergolas.

Verstärkungswinkel, wird bei starkem Wind empfohlen. Dieses Werkstück kann in allen Pergolas eingesetzt werden.

Squadra di rinforzo, consigliata per zone esposte a forti venti. Pezzo valido per tutte le pergole.

Équerre de renfort, recommandée pour les zones exposées aux vents violents. Pièce valable pour toutes les pergolas.

Wall bracket, recommended for zones exposed to strong winds. Piece suitable for all pergolas.